















Farbmarken / Color Marks



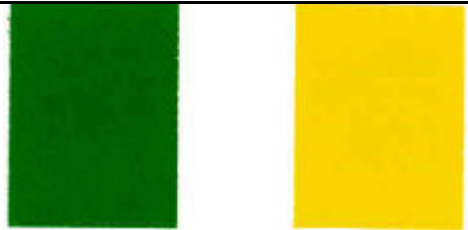

Land Country	Aktenz. Serial#	Marke Mark	Klasse Class	Anmelder Applicant	Status *	Check / Status
AT	52977		30	Kraft Foods Ltd	R	198
AU		Terracotta applied on polypipe fittings		Philmac pty Ltd	R	
AU	559837	green	4 37	BP plc	E O	2005
AU	661706	blue	11	Alfa laval agri	R	1998
AU	700016	blue	19	Carter hold harvey	R	1997
AU	704779	orange	33	Veuve clickot	R	1999
AU	710226	silver	29	Kraft foods ltd	R	2000
AU	711142	yellow	39	Yellow cabs (Queensland)	R	1999
AU	749403	 THREE HORIZONTAL STRIPES, ORANGE, GREEN & RED	35	7-Eleven, Inc	R	2000
AU	751852	Gelb / Yellow	1 9 16 35 40	Kodak (Australia) pty	R	2002
AU	762245	Gelb / schwarz Gelb / schwarz	12	Luk Lamellen und Kupplungsbau Beteiligungs AG	R	2003
AU	763168	purple	3	3M Australia Pty	R	2003
AU	771390	 Purple	30	Kraft foods Schweiz Holding	E O	2005
AU	773448	Yellow	39	Australian Postal Corp.	R	2001
AU	773449	Red / white	39	Australian Postal Corp	R	2001
AU	773450	Red	39	Australian Postal Corp	R	2001

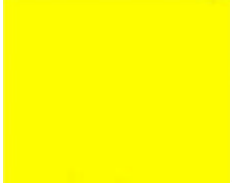



Anlage zu © Neue Markenformen – Farbmarken Dr. Ralf Sieckmann, Düsseldorf

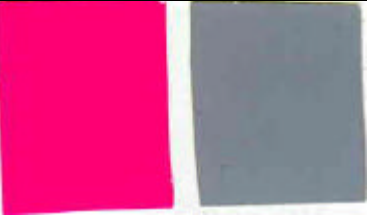



Annex to © Non-traditional Trade Marks - color trademarks colour trade marks http://www.copat.de/markenformen/mne_markenformen.htm



AU	773693	orange	5	Pfizer Inc.	R	2002
AU	780092	Blau / blue	6 9 20 39	Brambles Australia Limited	R	2001
Au	795001	Orange (pantone 151)	35 37 38	Orange Personal Communications Ltd	R	2002
AU	820449		35 37 38	Orange Personal Communications Ltd	R	2000
AU	898187	The color yellow	5	Schering Pluogh	E	2005
AU	909518	The color Green	1 4 37	BP plc	R	2004
AU	922022	Blue and silver stripes	32	Red Bull GmbH	R	2005
AU	924454	Blue	14 21	Wedgwood ltd	R	2005
AU	926016	Yellow pantone 012	6 17 35 37	Hydraulink Fluid connectors	E	2005
AU	932937	The color purple	31	Effem Foods ply	E	2005
BX	382253		30	Kraft Foods	R	198
BX	502608		4 37 39 43	BP		1991
BX	551370		3 24 25 27 35	Laura Ashley Manufacturing	R	1994
BX	C104/01 [EuGH] of 06.05.03	 Orange (als Muster angemeldet / applied for as color sample only)	9 35 36 37 38	Libertel Groep BV	A W	2003
CA	519025	rosa		Owens Corning	R	199
CA	522834	blau		Dow Corning		199

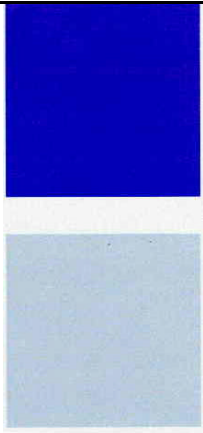

DE	39407183	 grün, gelb / green, yellow	7	Deere & Company	R	2000
DE	39407185	 grün, gelb / green, yellow	7	Deere & Company	R	2000
DE	39409484	 gold, gelb gold, yellow	11	DAL GmbH & Co KG	R	2002
DE	39515536	 saatengrün / seed green	7	Claas KG aA	R	2001
DE	39533891	 ...Gelb (durchgesetzt, aquired distinctiveness)	39	Deutsche Post	R	2003
DE	39541406	 Violett (durchgesetzt, aquired distinctiveness)	5 (Abfüllmassen)	3M Espe AG	R	2000



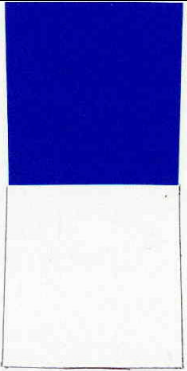

DE	39545044		4	ARAL AG	R	2003
						Blau HKS47 100%, weiß (durchgesetzt, aquired distinctiveness)
DE	39545083		4	ARAL AG	R	2003
						Blau / Blue HKS47 100% (durchgesetzt, aquired distinctiveness)
DE	39552629		9 16 37 38 42	Deutsche Telekom AG	R	2001
						magenta, grau / magenta, grey
DE	39552630		9 16 37 38 42	Deutsche Telekom AG	R	2000
						magenta (durchgesetzt, aquired distinctiveness)
DE	39725801		6 7 9 11 12 17	Wampfler AG	R	2000
						zitronengelb, silbergrau, anthrazit, tiefschwarz / lemon yellow, silver grey, anthracite, dark black

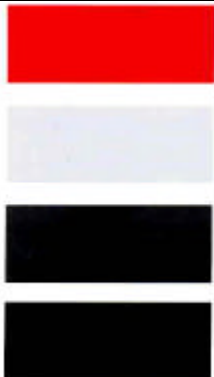



DE	39757188	Gelb / schwarz	12	Luk		2005
DE	39875412	 orange	31 (Saatgut)	KWS Saat AG	R	2001
DE	39904508	 violett P 28730,S 28900,P 28765	31 (Tierfutter)	Effem GmbH	R	2004
DE	39919998	 grün / green RAL 1506040	11 17 19	Aquatherm GmbH	R	2004
DE	39919999	 ...grün / green RAL 1704040-1506040	11 17 19	Aquatherm GmbH	R	2003





DE	39921546		blau, grau / blue, grey	35 36 37 41 42	Drees & Sommer AG	R	2000
DE	39927141		Pantone,13-0859Tc-19-3955Tc	18 20 21 22 25 27	LARCA Sportartikel GmbH	R	2003
DE	39932963		blau, bernstein / blue, amber	35 38 41	Kienbaum Consulting	R	1999
DE	39932964		bernstein, blau, weiß / amber, blue, white	35 38 41	Kienbaum Consulting	R	1999

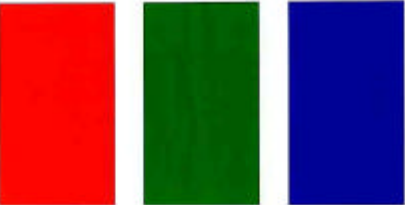





DE	39932966	 <p>blau, weiß / blue, white</p>	35 38 41	Kienbaum Consulting	R	1999
DE	39972469	 <p>rot, grün / red, green</p>		Melitta	R	2002
DE	30038516	 <p>hellgrün (Pantone 375 C), dunkelgrün (RAL 6002), rot (RAL 3020), weiß (RAL 9010) light green (Pantone 375 C), dark green (RAL 6002), red (RAL 3020), white (RAL 9010)</p>	3	Zielinski, Gabriele	R	2001



DE	30057885	 <p>verkehrsrot, lichtgrau, basaltgrau, tiefschwarz / traffic red, light grey, basalt grey, dark black</p>	39	Deutsche Bahn AG	R	2001
DE	30084703	 <p>hellblau, grün / light blue, green</p>	9 16 38	Urban & Fischer	R	2001
DE	30116169	 <p>grün, gelb, rot / green, yellow, red</p>	31	Becker, Jun.	R	2001

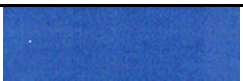

DE	30124494	 <p>Zinkgelb, verkehrsrot, verkehrsblau / zinc yellow, traffic red, traffic blue</p>	4 9 38	Germann Immobilien & Verwaltungs GmBH	R	2002
DE	30124495	 <p>blutorange, pastelorange / blood orange, pastel orange</p>	4 9 38	Germann Immobilien & Verwaltungs GmBH	R	2002
DE	30127389	 <p>gelb HKS 5, violett HKS 34</p>	12	Wohlfarth	R	2003
DE	30129024	 <p>gelb, blau / yellow, blue</p>	35 36 38	BVL Bürosysteme Vertriebs GmbH	R	2001







DE	30129947	 Grün / green Pantone 236	36	Dresdner Bank AG	R	2004
DE	30137245	 blau, grün, rot, grau / blue, green, red, grey	35 42	Rae Rayermann Zimmer	R	2001
DE	30153125	 verkehrsorange, minzgrün, signalblau / traffic orange, mint green, signal blue	7	Vogel Industrie GmbH	R	2002
DE	30166245	 blau, violett, rot / blue violett, red	12 25 35 37	Bayrische Motoren Werke AG	R	2002





DE	395 1 C049/02 [EuGH])	 <p>Die o.g. Wiedergabe zeigt nur die Wiedergabe der beiden Farben anhand einer älteren Markeneintragung der Antragstellerin. Bei der angemeldeten Marke handelt es sich um die Firmenfarben der Anmelderin, die in jeglichen denkbaren Formen benutzt werden, insbesondere für Verpackungen und Etiketten. Die genaue Bezeichnung der Farben ist wie folgt: RAL5015/HKS47 - blau, RAL1016/HKS3 – gelb The above representation shows the color combination as used in an elder trade mark registration of the applicant. The exact definition of the colors is RAL5015/HKS47 - blue, RAL1016/HKS3 - yellow</p>	1 2 3 4 5 6 7 8 9 17 19 20 24	Heidelberger Bauchemie GmbH	A	2004
DE	30225091	<p>Farbe Grün (RAL 6018), in der die Gehäuse der beanspruchten Waren ausgeführt sind.</p>	9	Jürgen Spelsberg GmbH & Co KG	R	2004
DE	30231621	 <p>rot / red (RAL 3000)</p>	7	KTR Kupplungs- technik GmbH	R	2003
DE	30253370	 <p>Grün, grün, gelb / green green yellow</p>	4	Deutsche BP	R	2004
DE	302253369	 <p>grün/ green (P 348C), gelb / yellow (P 109C)</p>	4	Deutsche BP	R	2004
DE	30259878	 <p>Gelb / yellow HKS 3</p>	39 40	YELLO Strom	R	2004

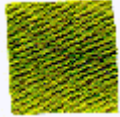

DE	30301934	 Pantone grün C	9 16 35	Fraunhofergesellsc haft	R	2003
DE	30344272	 rot / red Pantone 485 C	10	Matsushita	R	2004
DE	30359376	 kupfer / copper (pantone orange Nr. 021C mit metallic-effekt)	30	FerreroOHG	R	2004
DE	30362221	 blau / blue pantone 392	1 17	Siga Cover	E	2005
DE	30362241	 grün / green pantone 376	17	Siga Cover	E	2005
DE	30362242	 ... Gelb pantone process yellow	17	Siga cover	E	2005
DE	30362522	 blau / blue grün / green Ral 280 40 45 Ral 150 60 40	19	Aquatherm GmbH	R	2004

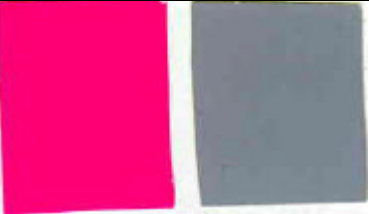



EM	1991	 <p style="text-align: right;">}(durchgesetzt)</p> <p>Besteht aus der Farbe Grün, wie auf der Außenfläche der Verkaufsräumlichkeiten angebracht. Die Eintragung dieser Marke berechtigt nicht zur exklusiven Benutzung der Farbe Grün, wie sie für Pumpen, Düsen und Schläuche für die Abgabe von bleifreiem Benzin verwendet wird. The mark consists of the colour green as applied to the exterior surface of the premises used for the sale of the goods and services. Registration of the subject mark shall give no right to the exclusive use of the colour green as applied to pumps, nozzles and hoses used for the delivery of unleaded petrol.</p>	4 37	BP p.l.c.	R	2001
EM	31336	 <p>Lila, einfarbig wie in der Wiedergabe. lilac, one color as in the representation</p>	30	Kraft Foods Schweiz Holding AG	R	1999
EM	46565	 <p>Schwarz (RAL 2005) / Zinkgelb (RAL 1018) Black: RAL 9005, zinc yellow: RAL 1018.</p>	1 3 5 6 7 9 11 12 21 22 23 37 42	Alfred Kärcher GmbH & Co	A E W	2002





EM	51607	 <p>Besteht aus der eigentlichen Farbe Hellgrün in der speziellen Tönung, wie sie das beigefügte Farbmuster wiedergibt. Der Markenschutz wird für diesen speziellen Farbton beansprucht und nicht für die besondere rechteckige Form des Farbmusters. Zur Stützung dieser Anmeldung hat der Antragsteller darüber hinaus eine Standard-Farbtafel beigefügt. Der senkrechte Block in der Mitte dieser Tafel zeigt den speziellen Grünnton, dessen Schutz beantragt wird, die anderen Quadrate geben die verschiedenen Farbtoleranzen dieser speziellen Tönung wieder.</p> <p>The trademark consists of the colour light-green itself in the specific hue as is shown on the enclosed specimen of the colour. Trademark protection is claimed for this specific hue of the colour and not for the particular rectangular form of the colour specimen. Also enclosed is "Color Standard Chart" from the Applicant in support of this application. The vertical block in the middle of this chart shows the colour green in the specific hue claimed, the other squares show the various colour tolerances of this specific hue.</p>	3 5 30	WM Wrigley Jr. Company	A W	2001
EM	52035	 <p>Das Markenzeichen besteht in der speziellen Schattierung der Farbe Gelb, wie sie das beigefügte Farbmuster zeigt. Markenschutz wird beansprucht für die spezielle Färbung als Grundfarbe des Verpackungsmaterials für die eingetragenen Waren und nicht für die besondere rechteckige Form des Farbmusters. Darüber hinaus hat der Antragsteller als Beleg seiner Anmeldung eine Farbenkarte beigefügt. Der vertikale Block in der Mitte der Karte zeigt die Farbe Gelb in der speziellen Schattierung gemäß dem Anspruch, die Quadrate</p>	3 5 30	WM Wrigley Jr. Company	A W	1999

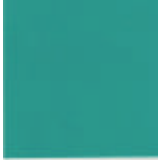

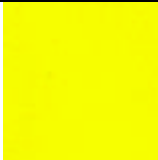

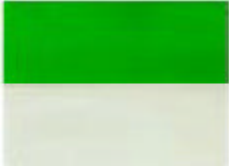

		zeigen die verschiedenen Farbtoleranzen dieser speziellen Schattierung. The trademark consists of the colour yellow itself in the specific hue as is shown on the enclosed specimen of the colour. Trademark protection is claimed for this specific hue of the colour as the basic colour of the packaging material of the goods claimed, and not for the particular rectangular form of the colour specimen. Also enclosed is a "Color Standard Chart" from the Applicant in support of this application. The vertical block in the middle of this chart shows the colour yellow in the specific hue claimed, the squares show the various colour tolerances of this specific hue.				
EM	55475	 Farbe Türkis. The colour turquoise	9 16 36	Barclay's Bank	W	1999
EM	63289	 Grün: Munsell 9.47 GY3.57/7.45; Gelb: Munsell 5.06 Y7.63/10.66.	7 12	Deere & Company	R N	2001 2004
EM	127407	 Blau. Blue	4 37	ARAL AG	A W	2000
EM	142612		2 4	WD-40 MANUFACTURING COMPANY	W	2000
EM	152314	 grüngold auf der Warenoberfläche /green gold on the surface	7	QUALITEX Inc	W	1998
EM	156380	 Blau / blue	1	Compo GmbH & Co KG	W	



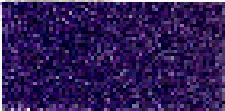

EM	171926	 Die Marke ist die Farbe Rosa. Die Marke beschränkt sich nicht auf die vier-eckige Form des vorgelegten Ausdrucks, sondern besitzt eine unbestimmte Form, da sie auf das Isoliermaterial des Produkts und seine Verpackung aufgebracht wird.	17	Owens Corning Inc	E W	2001
EM	212753	 Magenta Grau	38 42	Deutsche Telekom AG	R	2000
EM	212787	 Magenta Magenta	38 42	Deutsche Telekom	R	2000 2003
EM	240259	Rot: HKS 14; Pantone 1795; RAL 3020; Euroskala: 100% Magenta [rot], 80% Yellow [gelb] - Schwarz: HKS 88; Pantone Process Black; RAL 9005; Euroskala: 100 % Tiefe [schwarz], 100% Cyan [blau] - Lichtgrau: 25% HKS 88; Pantone 428; RAL 7035; Euroskala: 20% Tiefe [schwarz], 5% Cyan [blau].	4 37 39 42	RWE DEA	W	1999
EM	240952	 Orange	7 8 9 17	BV Holmatro Industrial Equipment	A W	2001
EM	275487	 Pantone 3125 C (türkis) / Pantone 3125 C (turquoise)	17	Busak & Shamban GmbH & Co	A W	2002







EM	282079		...Schwarz und gelb (pantone 108)	9	FSI Fonts und Software	W	1
EM	283530		RAL 2001-HR (orange)	7	C & E Fein GmbH & Co KG	A W	2002
EM	319962		Dunkelgrau = UN 9003, grün = UN 6007 (Farbspezifikation gemäß dem Standard "Universal Masterbatch Color-Service / Hainburg" für Kunststoff-Einfärbung). Farbkombinations-Marke; Uhrgehäuse: dunkelgrau; wenigstens eine Bedienungstaste im Uhrgehäuse: grün. / dark grey = UN 9003, green = UN 6007 (color specification according to Standard "Universal Masterbatch Color-Service / Hainburg for plastic coloring).	14	Junghans Uhren GmbH	A W	2001





EM	338194	 Orange (Pantone 164c) und Grau (pantone 428) / orange (pantone 146c) and grey (pantone 428)	7	Andrea Stihl AG	A	2001
EM	343368	 Gelb (Die Munsel-Nummer der Farbe Gelb lautet 9 YR 7.36/14.6.)	9 16	FLUKE Corp.	W	2000
EM	355909	 feuerrot (RAL 3000) reinweiß (RAL 9010) tiefschwarz (RAL 9005).	7 9	Windmüller & Hölscher GmbH	R	2001
EM	374173	 Türkis / Turquoise.	1 16 17	Perfecta Chemie BV	W	1999
EM	378224	 Pantone 1555 C (rosa) / The trademark consists of the pink shade PANTONE 1555 C, as represented in the brand model, corresponding to the colour of the product.	3	Lancome Parfums et Beaute & cie	A W	2002
EM	396176	 gelb / yellow	2 16 17	Northern Technologies Inc.	R	2001

EM	459149 T316/0 [EuG]	 <p>Die Marke ist eine Zusammenstellung von zwei Farben, die wiedergegeben ist durch ein grünes Rechteck mit dem Farbton Pantone 369c und ein darunter liegendes graues Rechteck mit dem Farbton Pantone 428u. / The trademark is a two color combination represented by a green rectangle having the color Pantone 369c and a rectangle below said rectangle in grey having the color Pantone 428u</p>	7	Viking-Umwelt-technik GmbH	A W	2002
EM	469213	 <p>hellgrün / light green</p>	7 12	Claas KG aA GmbH	A W	2001
EM	474106	 <p>Hellblau (pantone 290U)</p>	10	Arrow International	W	1999
EM	475210	 <p>blau pantone 289 / gelb pantone 123 (verkehrsrd.) blue pantone 289 / yellow pantone 123 (aquired Distinctiveness)</p>	16 39 42	S.N.C.F.	A R	2004



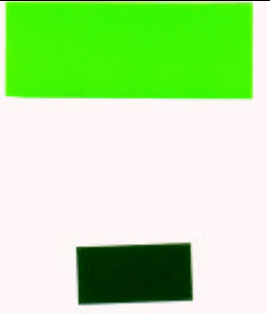

EM	524850	 RAL 2004 reinorange	7 8 9	Cooper POWER tools GmbH	W	2000
EM	546713	 dunkelviolet	7 8 12	Sparky trading	E W	2002
EM	565523	 }Blau (HKS 43 K) / Blue (HKS 43 K).	16 29 42	Staatl. Molkerei Wihenstephan	W	1999
EM	590307	 Dunkelviolet	3	3 M Company	W	2000
EM	611517	 }GRÜN HKS Nr. 55 K 55% / Green HKS Nr. 57K, 55%.	17	BASF AG	A W	2002
EM	6111558	 GRÜN HKS Nr. 64 K 30% / Green HKS Nr. 64 K, 30%	17	BASF AG	W	2000
EM	611566	 GRÜN HKS Nr. 55 K 30% / Green HKS Nr. 55K, 30%.	17	BASF AG	A W	2002







EM	611590	 GRÜN HKS Nr. 54 K 30% / Green HKS Nr. 54K, 30%.	17	BASF AG	W	2000
EM	611616	 GRÜN HKS Nr. 57 K 30% / Green HKS Nr. 57K, 30%.	17	BASF AG	A W	2000
EM	614420	 } Weiss / rot (pantone 032c) / Colour: white, red. (Other term for red colour: HKS 13 Pantone red 032c (100% yellow / 100% magenta))	9 16 38	Herlitz PBS AG	A R	2001
EM	619676	 Besteht aus der Farbe Rot (Pantone-Vergleichssystem 186), von der weiter oben ein Muster gezeigt wird; sie bedeckt die Waren vollständig oder zu einem wesentlichen Teil oder ihre sichtbare Oberfläche. / The mark consists of the colour red (Pantone Matching System 186), a sample of which is shown, covering the whole of, or a substantial part of, the visible surface of the goods.	6	The Crosby Group	A W	2003
EM	655019	 Kanariengelb Die Standardwerte (Koordinaten im Farbbereich) für die Marke sind: L = 93.77;a = -5.28;und b = 38.43.Die Farbnummern im Pantone Matching System®, die diesen spezifischen Koordinaten im	16	3 M Company	R	2004



		Farbbereich am nächsten kommen, sind Pantone® Nr. 106 60 %, Pantone® Nr. 601 100 %, Pantone® Nr. 101 50 % und Pantone® Nr. 100 60 %				
EM	683813	 violett	29 30	CADBURY	W	2000
EM	708776	 grün / green	4	Alexander Duckham	E W	2001
EM	711275	 RAL 1032 (gelb) / RAL 1032 (yellow)	16 35 36 38 39 42	Deutsche Post AG	A W	2001
EM	742304	 Gelb / Yellow	8 9 12 37 40 41	LuK Lammellen und Kupplungsbau GmbH	E A W	2002
EM	742379	 Gelb , Schwarz / yellow, black	8 9 12 37 40 41	LuK Lammellen und Kupplungsbau	E	2002
EM	747501	 Pantone 348 (grün) / Pantone 348 (green)	39	National Car rental Systems, Inc.	A E	2003
EM	747949		32 33	Veuve Clicquot Ponsardin	A	2004

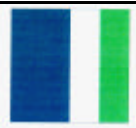



EM	904169	 <p>Panthone 375c (Hellgrün) / RAL 6002 (Laubgrün) / Pantone 375 (light green); RAL 6002 (leave green)</p>	3	Zielinki, Gabriele	A, W	2002
EM	905172	 <p>Türkis Orange / turqouis orange</p>	9 38 42	BELGACOM	W	2002
EM	944397	 <p>Die kolorimetrische Bestimmung des Farbtons nach der L*a*b*-Darstellung (Internationale Beleuchtungskommission - 1976) ist die folgende: L*=52.53; a*=60.39; b*=+26.23 (wobei L* den Helligkeitsfaktor angibt und a* und b* die Farbkoordinaten sind)..</p>	1 29 30	Etabl. Ancelm Fabrique	W	2003
EM	962076	 <p>(durchgesetzt /acquired dictinctiveness) braun /brown</p>	39	United Parcel Service of Amerika	R	2001



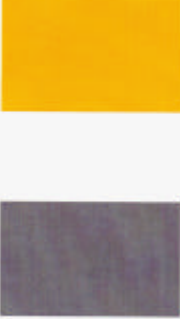
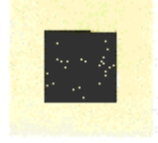



EM	968131		Lila und rot / lilac and warm red	9 38 42	Belgacom	W	2002
EM	988865		apricot	6 11 20 21	HEWI	W	2001
EM	1000082		Gelb / yellow	4	LuK ...	W	2001
EM	10000132		Gelb / schwarz	4	LuK	W	2001
EM	1004217		Pantone 343c	20 24 25 27	Laura Ashley	W	2000
EM	1014166		Besteht aus der Farbe Blau, wie oben gezeigt, auf der Außenfläche der die	16 17 41	3M Company	W	1999



		Anmeldung betreffenden Waren. / The mark comprises the colour blue as shown above, applied to the exterior surface of the goods covered by the application.				
EM	1029554	 Blau / blue PMS 300 U (durchgesetzt / aquired distinctiveness)	20 39	Brambles Australia	R	2003
EM	1074095	 Pantone 321 cv	16 28	melloc	W	2001
EM	1143569	 Hellblau (pantone 657u) / anthrazit (pantone 433u)	9 16 35 356 38 42	Landesbank Baden Württemberg	W	2001
EM	1144057	 Hellblau (pantone 657u)	9 16 35 356 38 42	Landesbank Baden Württemberg	W	2001
EM	1174143	 } Gelb (Pantone 13-0859TC); Blau (Pantone 19-3955TC). blue (Pantone 19-3955TC). Yellow (Pantone 13-0859TC);	9 12 18 20 21 24 25 27 28	Larca Sportartikel	E A W	2003

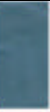

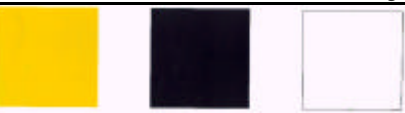

EM	1178904	 enzianblau RAL 5010; pastellorange RAL 2003	7 9 42	Rexroth Indramat	W	2001
EM	1178938	 enzianblau ral 5010; signalweiß ral 9003; pastellorange ral 2003	7 9 42	Rexroth Indramat	R	2000
EM	1179035	 enzianblau RAL 5010; signalweiß ral 9003; verkehrsgrün RAL 6024	7 9 42	Rexroth Indramat	R	2000
EM	1179076	 enzianblau ral 5010; signalweiß ral 9003; pantone 108	7 9 42	Rexroth Indramat	R	2000
EM	1189471	 Schwarz / black orange (RAL 2008)	12 36 39	SIXT AG	E W	2001
EM	1222330	 Gelb / yellow schwarz / black	7	The Black & Decker	E O	2003
EM	1222413	 Gelb / yellow schwarz / black	7	The Black & Decker	E O	2003







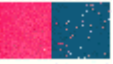
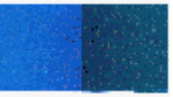
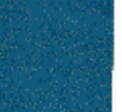

EM	1222561	 Gelb / yellow schwarz / black	7	The Black & Decker	E O	2003
EM	1233485	 Rot / red	7 8	Harvard International	E W	2000
EM	1279637	 dunkelblau / dark blue	11 16 20 21	SOFRIGAM	E W	2001
EM	1316611	 } Besteht aus der Kombination der Farben Gelb (Pantone 123) und Grau (Pantone 431), die auf Waren aus der Liste der Waren und Dienstleistungen dieser Anmeldung angebracht sind. The mark consists of the combination of the colours yellow (as defined by Pantone No 123) and grey (as defined by Pantone No 431) applied to any of the goods included in the list of goods and services covered by this application.	7 17 21	Hozelock Ltd	R	2003
EM	1318658	 Anthrazit 100 % HKS 93; Chamois 30 % HKS 1 und 70 % weiß Die Farbe chamois bildet stets den Hintergrund für einen in anthrazit gehaltenen Aufdruck, welcher Symbole oder auch Schriftzeichen in Form von Buchstaben enthalten kann	16 20 25	März München AG	E W	2001









EM	1318898	 Hellblau / light blue	6 7 11 17	Tecnosystemi	E W	2001
EM	1328756	 Gelbverlauf von 100% Skalengelb bis 0% entsprechend der Europalette oder Gelbverlauf von 100% Process Yellow bis 0% Process Yellow entsprechend Farbsystem Pantone oder Gelbverlauf von 100% HKS 3 bis 0% HKS 3 entsprechend Farbsystem HKS	1 5 20 21	W Neudorff GmbH KG	E W	2003
EM	1334192	 Rapsgeilb (RAL 1021), Himmelblau (RAL 5015)..	9	SICK AG	E W	2000
EM	1346931	 Türkis / turquoise	29	H.J. Heinz Company	E W	2001
EM	1353358	 Magenta: RAL 4010 bzw. Pantone Phodamine Red U	9 16 36 37 38 41 42	Deutsche Telekom	E W	2003







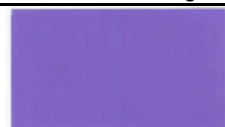

EM	1355015	 Magenta: RAL 4010 bzw. Pantone Phodamine Red U; Grau: RAL 745 bzw. Cool Grey 7 U	9 16 36 37 38 41 42	Deutsche Telekom	E W	2003
EM	1419555	 Gelb / yellow: HKS 4; blau / blue: Pantone 280; rot / red: HKS 14	9 14 16 18 25 28 35 36 38 39 42	Deutsche Post AG	E A W	2004
EM	1422005	 Gelb / yellow: HKS 4; blau / blue: Pantone 280	9 14 16 18 25 28 35 36 38 39 42	Deutsche Post AG	E A W	2004
EM	1422203	 Blau / blue	8	Philips Screw Company	E W	2002
EM	1422963	 Gelb / yellow : HKS 4, rot / red: HKS 14	9 14 16 18 25 28 35 36 38 39 42	Deutsche Post AG		2004
EM	1423698		9 14 16 18 25 28 35 36 38 39 42	Deutsche Post	E A W	2004
EM	1426493	 gelb / yellow HKS 4, Schwarz / black	9 14 16 18 25 28 35 36 38 39 42	Deutsche Post	E A W	2004
EM	1485093	 Fluoreszierendes Gelb	12 28 35 41	Jordan Grand Prix	E W	2004



EM	1520451	 orange	9 16 35 38 41 42	Big Words	E W	2003
EM	1536820	 Rot / red (pantone warm red c); gelb / yellow (pantone 1235 c)	1 2 17 19 27	SIKA AG	E W	2004
EM	1556711	 orange	6 8 16 20 42	Julius Blum	E W	2002
EM	1580588	 Reflex blau / blue	36 38 42	Banco Bilbao	E W	2002
EM	1599935	 Blau / blue	35 39	GALOL	E W	2001
EM	1606565	 Orange	39	TNT Holdings	E W	2002
EM	1631340	 PANTONE 109 C gelb / yellow, PANTONE 1795 C rot / red	32	Pago international GmbH	E W	2001
EM	1728419	 Kieselgrau RAL 7032; Grafitschwarz RAL 9011	6 7 9	Selcom Spa	E W	2001
EM	1771005	 Besteht aus der Farbe, die mit der Pantone-Farbe warmes Rot C dargestellt wird, die als vorherrschende Farbe die sichtbare Oberfläche von Warenverpackungen bedeckt. / The mark is the colour represented by Pantone Colour Warm Red C being the predominant colour applied to the visible surface of the packaging of the goods.	34	FORINEX	E W	2002







EM	1771039	 Besteht aus der Farbe Pantone Grün 340C als vorherrschende Farbe der sichtbaren Oberfläche der Verpackung der Waren. / The Mark is the colour represented by Pantone Colour Green 340C it being the predominant colour applied to the visible surface of the packaging of the goods.	34	FORINEX	E	2000
EM	1772961	 Orange Pantone 165 C	30	Carl Jürgen Brand	E W	2001
EM	1794072	 Rot / red pantone 206 C	7 9	Elletrotec s.r.l.	E W	2002
EM	1794098	 blau / blue (Pantone Nr. 308 C) rot / red (Pantone 1785C)	7 9	Elletrotec s.r.l.	E W	2002
EM	1794114	 blau / blue (Pantone 300U und Pantone 308C)	7 9	Elletrotec s.r.l.	E W	2002
EM	1794122	 blau / blue Pantone 308C	7 9	Elletrotec s.r.l.	E W	2002
EM	1796291	 Gelb / yellow pantone 106C	9	CABOT	E W	2001
EM	1808377	 Weiß / white	9	Horizont Gerätewerk	E W	2001







EM	1808393	 Grün / green	9	Horizont Gerätewerk	E	2001
EM	1842608	 blau / blue pantone 2915C	34	John Players & Sons	E W	2002
EM	1842673	 Blau/ blue Pantone 2995C	34	John Players & Sons	E W	2002
EM	1848894	 Besteht aus der hinterlegten präzisen Wiedergabe des Farbtons, der wie folgt definiert ist: 11 pts WARM RED, 4 pts BLACK, 5 pts RUBINE RED The trademark consists of the exact shade of colour represented in the application and defined as follows: 11 pts WARM RED, 4pts BLACK, 5 pts RUBINE RED)	33	Champagne Vranken S.A.	E A W	2004
EM	1863232	 Violett / violet	5	3M ESPE AG	E W	200
EM	1958032	 Die Marke besteht aus der Kombination der Farben Rot (Pantone 485 C) und Grün (Pantone 3425 c)	11 16 21 30	Melitta Haushaltsprodukte	E W	2002
EM	2015857	 Grün: HKS 58 aufgeteilt in: C 90%, M 40%, Y 80%, K 65%; Gelb: HKS 4 aufgeteilt in: M 25 %, Y 100 %	31 40 41 42	Hüttner	E W	2002
EM	2037356	 Orange HKS 7	31	KWS Saat	E	2005
EM	2057156	 gelb	7 12	J.C. Bamford Excavators	E A	2004







EM	20849978	 orange	9 38	Orange Personal Communications	E R	2004
EM	2087005	 Rot RAL 3003 (durchgesetzt / aquired distinctiveness)	8 (Messer, Knives)	VICTORINOX	R	2004
EM	2089605	 Grün / green Pantone 355c	30	H.J. Heinz Company	E W	2002
EM	2111797	 blau / blue	7	Galol S.A.	E A W	2003
EM	2123370	 violett / violet	16 17 20	Gebr. Van Leeuwen	E W	200
EM	2131720	 grün / green pantone 355c	30	H.J. Heinz Company	E W	2002
EM	2169563	 Violett / violet Pantone 272c	37 38 42	Spie Trindel	E W	2002
EM	2176519	 Bordeauxmetallic, gelbmetallic meliert	29 32 33	Cielo Spa	E W	2002
EM	2177566	 Blau / blue : Ral 5015, Rot / red: Ral 2002; Verteilung der Farben und Verhältnis der Farben zueinander 50:50	6 11 19 20	Gugelfuss	E A R	2005





EM	2228344	 Gelb grün blau / yellow green blue	35 37 39 40 42	RWE Umwelt AG	R	2002
EM	2255602	 blau weiß grün / blue white green	9 16 36	Standard Chartered Plc	E W	2004
EM	2297604	 Gelb / yellow Schwarz / black	7	The Black & Decker Corporation	E 0	2005
EM	2298719	 Gelb / yellow Schwarz / black	7	The Black & Decker Corporation	E 0	2005
EM	2342665	 grün / green RAL 6029; Chamois RAL 1015	35 36 42	Gastro Consult	E R?	2005
EM	2389724	 Pantone (RAL 2002)	7 9 11	Pompes Salmson	E W	2003
EM	2430916	 grün / green pantone 343c	3 24 25 27 35 42	Laura Ashley Manufacturing	E W	2003
EM	2467876	 Blau, violett, rot / blue , violet, red	12 25 35 37	BMW AG	E	2005





EM	2476224	 hellblau / light blue (pantone 304) orange (pantone 152)	30 42	San francisco coffee company	E R?	2005
EM	2494417	 orange (RAL 2000)	7 8 9 42	MSK Verpackung	E	2005
EM	2523538	 La couleur la plus foncée est composée de 100% de ciel; magenta 79%, jaune 0% et noir 80%; la partie la plus claire et composée de 100% de ciel, magenta 79%, jaune 0% et noir 10%	29 30	Europeene de condiments	E	2003
EM	2532471	 Orange (PMS 159C); blau / blue (PMS 303C)	8	Kapman AB	E A	2005
EM	2534774	 Der beantragte Schutz umfaßt die Farben Blau (RAL 5002) und Silber (Ral 9006) an sich	32	Red Bull GmbH	E	2005
EM	2550457	 kanariengelb /n canary yellow	16	3M Company	E	2005
EM	2571354	 Céladon (Pantone n° 7473U)	12 20	Glaverbel S.A.	E W	2004

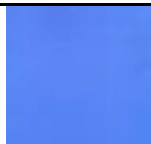





EM	25807434			12 37	FILCO GmbH	E W	2004
EM	2600989	 scale	HKS 5 Gelb / yellow , Schwarz Euro-Skala / black Euro	19 35 37	Xella Porenbeton	E	2005
EM	2618668		Orange blau / blue	7	Inter products B.V.	E	2005
EM	2674307		grün / green (pantone 363)	6 7 19	SPX Corp.	E	2005
EM	2695732		Türkis / Turquoise (Pantone No. 3268)	1 3 4 6 9 11 12 14 16 17 18 19 21 25 28 34 35 36	Petroliam National Behad	E W	2004
EM	2708634		Rot / red (70 %); gelb / yellow (30 %) (die Farbe Gelb ist Pantone Nr. 108, die Farbe Rot wurde auf Grundlage einer Reflektionsmethode bei Zimmertemperatur und auf einem weißen Hintergrund mit folgendem Ergebnis gemessen: L: 5,00 A: 24,60 B: 7,66)	33	Flügel Enterprises	E	2005
EM	2709731		blau / blue (pantone 532 C)	16 41 42 43 44	The Ritz Hotel	E W	2003

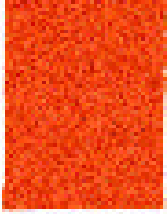

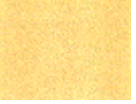



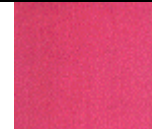
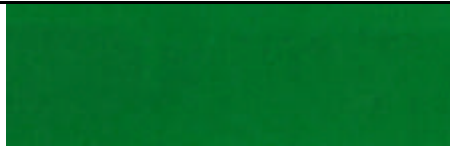

EM	2709756	 gold pantone 872	16 41 42 43 44	The Ritz Hotel	E W	2003
EM	2710200	 Grün / green (pantone 371 C)	27	Milliken Industrial Ltd	E	2005
EM	2712412	 grau / grey pantone cool grey 7	1 3 4 6 9 11 12 14 16 17 18 19 21 25 28 34 35 36	Petroliam National Behad	E W	2004
EM	2712610	 - grau / grey pantone cool grey 4	1 3 4 6 9 11 12 14 16 17 18 19 21 25 28 34 35 36	Petroliam National Behad	E W	2005
EM	2712891	 - grau / grey pantone cool grey 10	1 3 4 6 9 11 12 14 16 17 18 19 21 25 28 34 35 36	Petroliam National Behad	E	2005
EM	2716843	 Gelb / yellow , schwarz / black	7 9 20	The Black & Decker Corp.	E	2005
EM	2741023	 Blau / blue (RAL 5015) grau / grey (RAL 7031)	6 8 20	Unior Kovaska	E A W	2005









EM	2769404		Die Farbe Blau mit platinfarbenen Flecken..	20	DataCard Corp.	R	2004
EM	2783686		Blau / blue (pantone 293) grün / green (pantone 354)	36	Lloyds TSB Bank Plc	E	2005
EM	2785384		gelb / yellow schwarz / black	7 12 37	J. C. Bamford Excavators Ltd	E A	2005
EM	2822476		Gelb / yellow (Pantone 130), Blau / blue (Pantone 293)	36	Banca Intesa S.p.a.	E W	2004
EM	2825099		0 % Grün / green: RAL HKS 57, 60 % Gelb / yellow: RAL HKS 2	7 11 35 37	Mann & Hummel GmbH	E R?	2005
EM	2826428		blau / blue	14 21	WEDGWOOD Ltd	E	2005
EM	2829216		Hellblau / light blue (pantone 3115c) bordeauxrot (pantone 215c)	39 40	Essent N.V.	E R?	2005





EM	2851657	 graugrün / gery green (pantone 5483 C)	5 30 44	Kaniedenta GmbH & Co KG	E	2005
EM	2852655	 Markenschutz wird beansprucht für eine Kombination von drei Farben, nämlich von blau, grün und violett, und zwar jede Farbe jeweils in einer helleren und einer dunkleren Schattierung (Farbmuster siehe Anlage); die drei helleren und die drei dunkleren Farben sind jeweils in horizontalen oder vertikalen Farbstreifen beliebiger Breite und Höhe angeordnet, wobei die dunkleren Farbfelder bei horizontaler Anordnung über und/oder unter den helleren Farbfeldern und bei vertikaler Anordnung rechts und/oder links neben den helleren Farbfeldern angeordnet sein können	16 35 41	IDG Entertainment Verlag	R	2004
EM	2854958	 Mittelblau / middleblue (pantone 2718 C)	5 30 44	Kaniedenta GmbH & Co KG	E	2005
EM	2878114	 Himbeer / raspberry	3 8 9 11 13 14 16 18 20 21 25 28 33 34 35	Garrard Holding Holding	E	2005





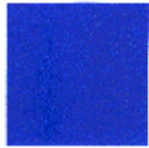
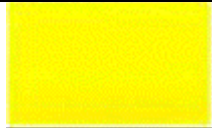

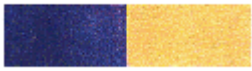



EM	2878171	 purpur /purple	3 8 9 11 13 14 16 18 20 21 24 25 27 28 33 34 35	ASprey	E W	2005
EM	2897031	 hellgrün / light green (pantone 368)	1	Accessories Marketing Inc.	E	2005
EM	2898971	 Ziegelrot /brickred	20 27 28	Janssen Fritsen Holding	E W	2004
EM	29	 rot /red pantone 193	9	Sierra Wireless	E W	2004
EM	2936375	 grün / green RAL 6019	9	Günther Spelberg	E	2005
EM	2965549	 Orange La marque est constituée par la nuance de couleur des	3 8 9 14 16 18 21 24 25	HERMES international	E	2005







		conditionnements des produits. Elle se caractérise comme suit: L : 58.32 a : 41.91 b : 48.06 avec un delta E de 2 (mesure effectuée sous une illuminance de D 65/10°)..				
EM	3000700	 Cadmiumgelb RAL 1021	9 10	XYLON GmbH	E	2005
EM	3011855	 Pantone 212C	1 3	Renkitt & Colman	E	2005
EM	3011863	 violett Pantone 266C	1 3	Renkitt & Colman	E	2005
EM	3011871	 rot pantone 184C	1 3	Renkitt & Colman	E	2005
EM	3012846	 rosa Pantone 232C	1 3	Renkitt & Colman	E	2005
EM	3077625	 Grün / green RAL 5018	7 9 11 12 16 35 36 37 38 41 42	Siemens AG	E	2005
EM	3086923	 orange	9 38	Orange Personal	E	2005
EM	31103157	 Blau / blue pantone 301	35 42	Thomas & Betts international	E	2005











EM	3119922	 Verkehrsrot RAL 3020	7 9 11	Hydac technology	E	2005
EM	3145224	 Pantone 4-116	30	Fauchon	E	2005
EM	3151008	 gelb schwarz / yellow black	9 16 35 36 42	ARAG Allgemeine Rechtsschutz- Versicherungs-AG	E R	2005
EM	3160074	 NCS S 1070-Y10R (yellow).	20 35	Inter IKEA	E W	2005
EM	3160199	NCS S 4550-R80B (blue).	20 35	Inter IKEA	E W	2004
EM	3160363	 NCS S 4550-R80B (blue) NCS S 1070-Y10R (yellow)..	20 35	Inter IKEA	E A	2005
EM	3179281	 Pantone 131c	1 9 14 15 16 28 35 36 38	FNAC	E	2005
EM	3187242	 Orange pantone 21	35 37 39	B & Q PLC	E	2005
EM	3220134	 Purpur / purple Pantone 2623c	20 43	Whitebread	E	2005







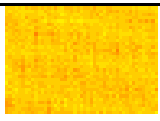

EM	3241205	 Himmelblau RAL 5015	17	Fietz GmbH	E	2005
EM	3243623	 Purpur / purple pantone 2655	9 10	Safeskin	E	2005
EM	3279361	 Signalblau RAL 5005	9	Krohne Messtechnik	E	2005
EM	3309721	 Schwarz (Pantone 426 C) Silbergrau (Pantone 877 C metallics).	9	VB Autobatterie	E	2005
EM	3314069	 Atlantik:Pantone 546C, Verkehrsschwarz: Pantone Black 2C 2X, Feuerrot: PAntone 485 C 2X..	7 9	Hans Einhell AG	E	2005
EM	3314184	 RAL 1002 sandgelb / sand yellow	6 11 17 19	Poloplast	E	2005
EM	3317948	 Blau / blue pantone 289 C, orange pantone 165C.	24 25 35	Gruppo coin	E	2005
EM	3370921	 blau / blue pantone 3005	7	Printing research	E	2005
EM	3396801	 Curry(ocker)gelb RAL6003-HR/ olivgrün RAL 1027-HR	7 8 9	PROXXON	E	2005

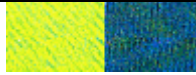





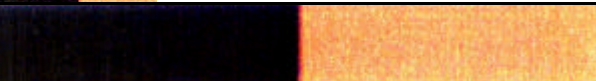

EM	3425311	 Rot RALI 3020	7	Hilti AG	E	2005
EM	3436961	 blau / blue Pantone 300C	35 38 40 41 42 44	TÜV Rheinland Holding	E	2005
EM	3441854	 gelb / yellow pantone 116C	39	Hertz	E	2005
EM	3485711	 grün / green pantone 350c	29 30 32	Tate & lyle	E	2005
EM	3525938	 gelb / yellow pantone 1235c	1 9 16 35 37 39	Eastman Kodak	E	2005
EM	3527579	 The mark consist of the colours blue (as exemplified by pantone number 662C) and yellow (as exemplified by pantone number 123C) being the predominant colours applied to the exterior surfaces of parts of vehicles service station	1 3 4 35 36	ConoccoPhilips Co	E	2005
EM	3549034	 .pantone 5425	3 14 16 20 21	Llandro commercial	E W	2004



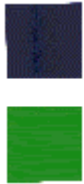

EM	3553187	 orange pantone 021.	38 39 43	Easy group ip	E	2005
EM	3553633	 Pantone 9721 c/u / RAL 9001	9 16 35 38 41	Daimler Crysler AG	E	2005
EM	3553641	 Pantone 8004 C / RAL 1035	9 16 41	Daimler Crysler AG	E	2005
EM	3553658	 Pantone 173c/U /Ral 2001	16 35 41	Daimler Crysler AG	E	2005
EM	3553773	 Pantone process blue	1 2 3	Akzo Nobel	E	2005
EM	3572021	 Gelb / yellow pantone 809	6	Gunnebo industrier AB	E	2005
EM	3578000	 silber / silver Pantone 877	16	Henkel KG aA	E A	2005
EM	3588779	   Blau / blue CMYK: C100/M75 , Weiß / white CMYK: CO/MO/YO/KO, Chrom / chrome CMYK: K30..	7 12 16 28 36 37 41 42	VW AG	E	2005
EM	3588787	 — Blau / blue CMYK: C100/M75, Weiß /white CMYK: CO/MO/YO/KO..	7 12 16 28 36 37 41 42	VW AG	E	2005





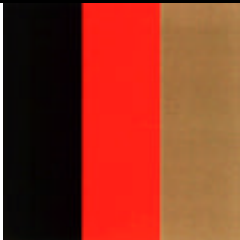

EM	3588811	 Blau / blue CMYK: C100/M75	7 12 16 28 36 37 41 42	VW AG	E	2005
EM	3615507	 Ral 8004 Kupferbraun / copper brown	11 17 19	Poloplast	E	2005
EM	3615771	 Terracotta (pantone 152)	16 35 41 42	Isenbruck bösl	E	2005
EM	3616208	 Taubenblau RAL 5014	11 17 19	Poloplast GmbH	E	2005
EM	3646783	 Die Marke weist kontinuierliche Übergänge von einem Farbstreifen in einen anderen auf.. Rot, Orange, Pink	5 10 35 39 40 41 44	Weihermüller & Voigtmann	E	2005
EM	3650769		20	Euro Pool system	E	2005
EM	3757473	 Grün / Green (Pantone 348C); gelb / yellow (Pantone 109C)..	4 37 39 43	BP p.l.c.	E R?	2005





EM	3766508	 Blau Pantone 314	3	Zino davidoff	E	2005
EM	3778669	 grün / green pantone 348C	4 37 39 43	BP p.l.c.	E	2005
EM	3789407	 Pantone 9c cool gray	37	Audi AG	E	2005
EM	3786423	 Pantone 186	37	AUDI AG	E	2005
EM	3790235	 Celeste (the colour is halfway between Pantone 3248 and 3258 with an iridescent appearance)..	9 12 25	Cycleurope AB	E	2005
EM	3793361	 Purpur pantone 248C	31	Mars U.K.	E	2005
EM	3806569	 gelb / yellow pantone 116C	9	KirbyMorgan Dive	E	2005
EM	3818069	 Red and gold colour combination; Pantone yellow PMS nr 116; red PMS nr 032..	16 31	Zespri Group	E	2005
EM	3818077	 . (Gold colour); Pantone colour specification PMS No. 116..	16 31	Zespri Group	E	2005
EM	3818085	 Bright green colour; Pantone colour specification unique colour, made from PMS yellow (34,8%), PMS green (12,1%), PMS white (51,6%)	16 31	Zespri Group Ltd	E	2005





		and PMS black (1,5%)..				
EM	3818093	 Light green/ dark green colour combination Pantone colour specification: light green - unique colour, made from PMS yellow (34.8%), PMS green (12.1%), PMS white (51.6%) and PMS black (1.5%); dark green PMS n° 3308	16 31	Zespri group ltd	E	2005
EM	3858602	 Gelb /yellow pantone process yellow	17	Siga Cover AG	E	2005
EM	3858611	 Grün Pantone 376	17	Siga cover AG	E	2005
EM	3858643	 Blau pantone 292	1 17	Siga Cover AG	E	2005
EM	3863891	 Pantone 226C	3	Reckitt Benckiser	E	2005
EM	3896883	 pantone warm red cool gray	7 8 9	Hans Einhell AG	E	2005
EM	3916483		8	Fiscars oys	E	2005
EM	3916616		8	Fiscars oys	E	2005
EM	3934081	 violett	6 11 37	Braunach	E	2005
EM	3939352	 Pantone PMS 186	18 25 28	Amer Sports GmbH	E	2005



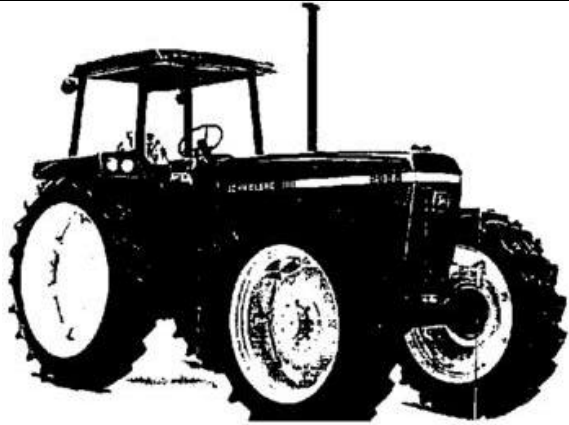

EM	3939386	 HKS 14	18 25 28	Amer Sports GmbH	E	2005
EM	3947496	 Blau-RAL5017, schwarz-RAL9011	12	CNH Global	E	2005
EM	3947512	 Blau-RAL5017, weiß RAL 9003, schwarz-RAL9011	12	CNH Global	E	2005
EM	3955515	 Orange (pantone 165C) and powder blue (pantone 291C).	12 25 28 41	Gulf Oil Marketing	E	2005
EM	3971273	 Enzianblau RAL 5010, Gelbgrün RAL 6018	4 35 37 39 43	OMV	E	2005
EM	3982576	 ?	35	DAMAS Europe	E	2005
EM	3985934	 Pantone 3005M (blau)	9 16 35 38 42	DSM Computer GmbH	E	2005
EM	3993071	 The colour combination red / yellow, for red; colour code pantone 485, for yellow; colour code pantone 137	36	Mastercard International Incorp.	E	2005

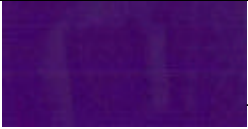

EM	3999386	 Pantone process blue	10 16	Zimmer GmbH	E	2005
EM	4028122		6 8 11 17 20 21	Krzysztof Pochyla trading as przedsiębiorstwo Wielobranżowe RAMP	E	2005
EM	4083119	 Black (corresponding to PMS Process Black), red (corresponding to PMS No. 1795)	5 29 30	Mars Inc.	E	2005
EM	4083259	 Black (corresponding to PMS Process Black), red (corresponding to PMS No. 1795) and gold (corresponding to PMS 873)	5 29 30	Mars Inc.	E	2005
EM	4083275	 The mark consists of the colour black (corresponding to PMS process black), as shown on the representation attached to the application, being the predominant colour applied to the whole visible surface of the packaging of the goods, the mark is not limited to the particular proportions nor	5 29 30	Mars Inc.	E	2005

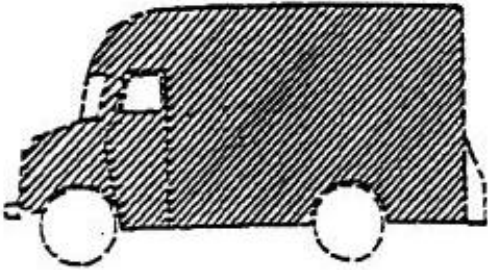

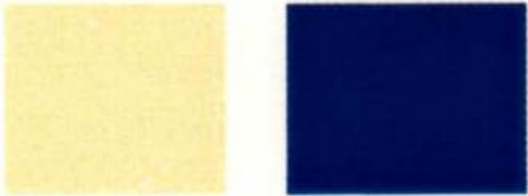

		the configuration of colour shown in the representation attached to the application				
EM	4088431	x Braun / brown	8	Fiscars ojj	E	2005
EM	4093431	 purpur (pantone 2855c)	9	Cadbury	E	2005
EM	4093449	 purpur (pantone 2855c)	30	Cadbury	E	2005
FR	9558173		3 24 25 27 35	Laura Ashley Manufacturing	R	1995
FR	98732057		4 37 39 43	BP p.l.c.	R	1998
FR	043268259	 The color(s) silver pantone 877 is/are claimed as a distinctive feature of the mark.	16	Henkel France S.A.	R	2004
GB	2042556	 Besteht aus der Farbe Lila, die als überwiegende Farbe auf der sichtbaren Oberfläche der Ware aufgebracht worden ist, die aus dem Muster ersichtlich The mark consists of the colour lilac, as shown on the form of application, being the predominate colour applied to the visible surface of the packaging for the goods	30	Kraft Foods Holding AG	R	1998

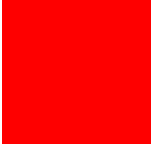

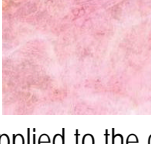
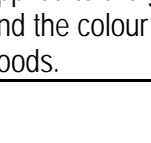
GB	2057893	 Die Marke besteht aus der Farbe Orange Pantone 151 als vorwiegender Farbe, die auf die sichtbaren Oberfläche von Verpackungen und / oder Werbematerialien aufgebracht wird. (Verkehrsdurchsetzung). The mark consists of the color orange pantone No 151 , being the predominant color applied to the visible surface of the packaging and / or advertising and promotional materials (Acquired distinctiveness).	9 38	Orange Personal Communication Ltd	R	1996
GB	2103551	The mark consists of the colour red, Pantone 485, as the predominant colour of the coloured surface of a passenger transport bus.	39	Transport for London	R	2000
GB	2126301	 Besteht aus der Farbe Purpur auf der Warenverpackung, wobei sich Farbe und Konfiguration aus der Anmeldung ergeben The mark consists of the colour purple as applied to the packaging of the goods, the colour and the configuration being as illustrated on the application form	30	Cadbury Ltd.	R	1999
GB	2240552C		4 37 39 43	BP p.l.c	R	2000
IT	719373		3 24 25 27 35	Laura Ashley Manufacturing	R	1997

NZ	220103	 <p>The trade mark consists of a green colour applied to the body of the tractor, a yellow colour applied to the wheels of the tractor and a yellow colour applied in horizontal stripes to the sides of a tractor, as shown in the representation attached to the application form.</p>	12	Deere & Company	R	1992
NZ	256793		4	Shell New Zealand	R	1997
NZ	285611	 <p>The mark consists of the colour purple as shown in the swatch attached to the application, used on or in association with the goods.</p>	30	Cadbury	R	2000
NZ	294930	 <p>The mark consists of the colour green (PMS 361C) as shown in the representation attached to the application, as applied to the packaging or promotional material used on or in association with the goods</p>	30	Soc. De Produits Nestle	R	2002

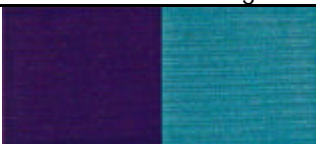
NZ	300375	 <p>The mark consists of the colour brown applied to the exterior surfaces of vehicles used for the supply of the said services as covered in the application.</p>	39	United Parcel Service	R	2002
NZ	309521	 <p>The mark consists of the colours red (close to or being PMS Warm Red) and yellow (close to or being PMS Yellow 012) as shown on the representation attached to the application</p>	41	Surf Life Saving New Zealand Inc	R	2001
NZ	607441	 <p>The mark comprises the colours cream (Pantone Cream 100C) and blue (Pantone Reflex Blue C) as shown in the representation attached to the application</p>	30	Soc. De produits Nestle	R	2002
NZ	609638	 <p>The trade mark comprises the colour peach for</p>	11	AUSTRALIAN CATERING EQUIPMENT PTY LTD	R	2001

		filters, filter socks and filter sleeves, used with animal milking apparatus and equipment as exemplified in the sample of filter bag material attached to the application form.				
NZ	609757	 The mark consists of the colour yellow (PMS 116 when printed upon coated paper, and PMS 109 when printed upon uncoated paper), as shown in the representation attached to the application.	9	National Geographics	R	2002
NZ	611312		39	TNT Holdings BV	R	2002
NZ	615104	 The mark consists of the colour pink (Pantone No. 1767) applied to the goods as shown on the representation attached to the application, and the colour pink (Pantone Nos 204 and 213) applied to the packaging for the goods.	17	Owens Corning Corp.	R	2002
NZ	622338	 The mark consists of the colour medium brown as shown in the representation attached to the application	39	United Parcel Servie	R	2003

NZ	639043	 The mark consists of the colour yellow (Pantone 012) as shown in the representation attached to the application.	6	HYDRAULINK FLUID CONNECTORS LIMITED	R	2002
NZ	639476	The mark is limited to the colours deep ocean green (PMS 3035 c) and red (PMS 485 c) as shown in the representation attached to the application.	1	Caltex	R	200
NZ	651134	 The trade mark consists of the colour yellow (Pantone 123) as represented on the application form, the trade mark being adopted as the predominant colour of an external surface or the external surfaces of packaging used in relation to the goods specified in the application form.	5	Schering Plough	R	2000
NZ	657521	 The trade mark consists of the colours Blue (RGB 14/49/146, CMYK 100/7/0/0) and Turquoise (RGB 1/156/177, CMYK 100/0/15/0), as shown in the representation attached to the application and as applied to the exterior and interior of buildings, and on promotional, marketing and advertising materials and on web pages; all being used in relation to the supply of the specified services	35	Mag & Turbo Warehouse Franchises Limited	R	2003
NZ	665511	 The mark consists of the colour green, Pantone 354, as illustrated on the accompanying swatch, used in association with the goods set out in the specification.	36	Lloyds Bank	R	2003

NZ	666094	 <p>The mark comprises the colour blue as the predominant colour, in combination with the colours yellow and red applied to the exterior of vehicles, to the exterior surfaces of buildings, to signage boards and to webpages where the vehicles, buildings, signage and webpages are all used to the provision of services covered by this application</p>	35	FREEHILLS CARTER SMITH & BEADLE	R	2003
NZ	680612	 <p>The mark consists of the colours blue (Process Cyan), green (PMS 375) and yellow (PMS 116) as shown in the representation attached to the application and used in combination on the specified goods or on packaging for these goods</p>	9	Telecom IP New Zealand	R	2004
RO	?	<p>The mark consists of the colour medium brown as shown in the representation attached to the application</p>	39	UPS	R	2004
US	1439132	THE DRAWING IS LINED TO INDICATE THE COLOR PINK	17	Owens Corning Corp.	R	1987

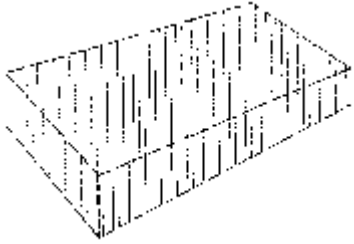
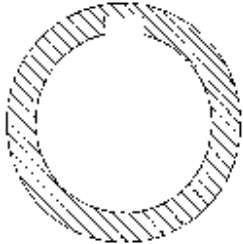
						
US	1633711	The mark consists of a particular shade of green-gold applied to the top and side surfaces of the goods. The representation of the goods shown in phantom lining not a part of the mark and serves only to indicate position.	7	Qualitex Company	R	1991
US	1670247	 THE MARK CONSISTS OF THE COLOR GREEN WHICH IS COEXTENSIVE WITH THE OUTER SURFACE OF THE GOODS. THE PHANTOM LINES MERELY REPRESENT THE POSITION OF THE MARK ON THE GOODS AND IS NOT A FEATURE OF THE MARK.	17	The Artus Corp.	R	1991

US	1774786		28	Quest custom Golf Inc.	R W	1993 / 2000
		The mark consists of interdigitated spirals of color on the shaft of a golf club.				
US	1787869	The mark consists of the color green as applied to ear cover domes of communication headsets. The configuration of a headset shown in dotted lines in the drawing is for illustrative purposes only and does not form part of the	9	David Clark Company	R	1993
		 mark.				

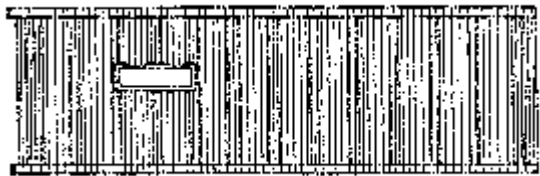
US	1841602		2	WD-40 Company	R	1994
		The mark consists of the color yellow on top of the color blue used on containers for the goods, the dotted lining reflecting the mode of use of the mark which is not limited to that particular container.				
US	1874209	 <p>The mark consists of the color burgundy with a white rectangular decal as applied to a solid waste container. The container is not claimed as part of the mark.</p>	37 39	Waste management Inc.	R	1995
US	1905643		19	Osmosr Inc.	R	1995
		The mark consists of the color yellow which serves as a background color on the labels attached to the goods.				

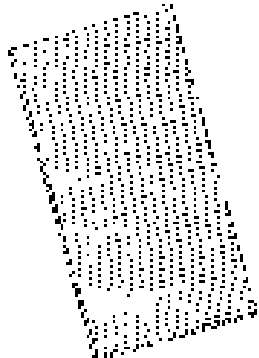
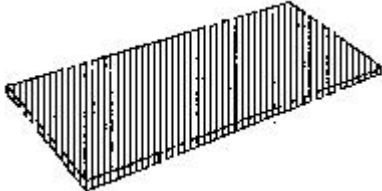
US	1931569	 <p>The matter shown by the dotted lines in the drawing is a configuration of the goods, is not a part of the mark, and no claim is made to it. The mark consists of the color blue used throughout the entirety of the goods.</p>	17	Dow Chemical	R	1995
US	2021137	<p>The color yellow is a feature of the mark. The drawing has not been lined for yellow because of space limitations. The color yellow is in graduated form, being brightest at the top of the matrix, and fading as the matrix descends</p>	5	Johnson & Johnson	R W	1996 / 2002
US	2090588		17	Owens Corning	R	1997

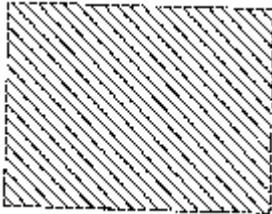
		The mark consists of the color pink as applied to the entirety of the goods. The dotted outline of the goods is intended to show the position of the mark and is not a part of the mark.				
US	2176916	The mark consists of the single color blue as applied to the entirety of the goods. The dotted lines merely indicate the position of the mark on the goods and do not form part of the mark.	17	3 M Company	R	1998
US	2218775	 <p>The mark consists of the color green used over the entire surface of the goods. The matter shown in the drawing in broken lines serves only to show positioning of the mark and no claim is made to it. The drawing is lined for the color green.</p>	10	Magnerite Inc.	R	1999
US	2390667	The mark consists of the color canary yellow used over the entire surface of the	16	3M Corporation	R	2000

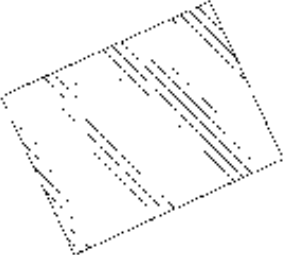
		goods. The matter shown in broken lines shows the position of the mark and is not claimed as part of the mark.				
US	2503197	 <p>The mark is a quadrilateral with opposite sides parallel and equal. The mark is lined for the color green.</p>	9	Digi International	R	2001
US	2678303	<p>The mark consists of a four part egg style carton in the color purple. The broken lines in the drawing represent the position of the goods within the package and are not meant as part of the mark</p>	30	Kraft Foods Schweiz Holding	R	2003

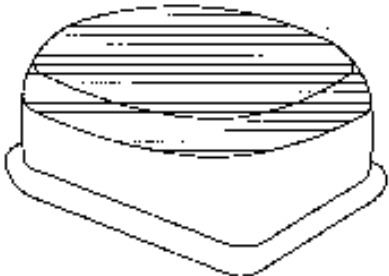
US		 <p data-bbox="472 443 1384 619">The mark is comprised of a three-dimensional rectangular tablet, with rounded edges and rounded top, divided horizontally by color with the bottom layer colored in white and the top layer colored in blue. Color is claimed as a feature of the mark. The drawing is lined for the colors blue and white.</p>	1 36 10	Benkiser	R	2002
US	2740473	<p data-bbox="472 1203 1395 1345">The mark consists of the colors green and brown. The drawing for the mark is lined for color as follows: the diagonal lining (in the direction from northeast to southwest) shown on the lower portion of the device indicates the color brown, and the diagonal lining (in the direction from</p>	5	Glaxo Group Ltd	R	2003

		northwest to southeast) shown on the remaining surface of the device indicates the color green. Color is claimed as a feature of the mark .				
WO	830984	 <p>The color silver pantone 877 is claimed as a distinctive feature of the mark</p>	16	Henkel France S.A.	R	2004

*

W = zurückgezogen oder zurückgewiesen, withdrawn or rejected

R = eingetragen, registered

E = geprüft, examination

A = Beschwerde, Appeal

O = Widerspruch, Opposition

N = Löschung, Nullification